

2

Using your Kenwood Audio/Video System

Spectrum 755 AV

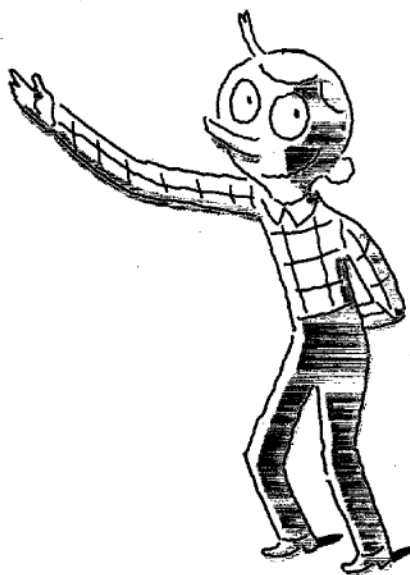

KENWOOD

Contents

Welcome	5	Before using the CD player	24
Using the controls	6	Compatible CDs	24
Front panel controls	6	Handling CDs	24
Reading the display	8	Cleaning CDs	24
Remote	10	Storing CDs	24
A few tips	10	Damaged CDs	24
Loading and replacing the batteries	11	Condensation	24
The basic audio functions	12	Before you transport your CD player	24
Selecting the input source	12	Displaying CD time information	25
Adjusting the volume	13	Loading CDs	25
Adjusting the bass and treble	14	Changing CDs	25
Muting the sound	14	Playing CDs	26
Activating the speakers	15	From the beginning	26
Adjusting the speaker balance	15	From a specific track	27
Using headphones	16	Playing a combination of tracks	28
About the audio modes	17	Programming tracks	28
Dolby Pro Logic	17	To check a program	29
Dolby 3 Stereo	17	To resume normal play	29
Bypass	17	To cancel a program and stop play	29
Selecting an audio mode	18	Adding a track to a program	29
Using the tuner	19	Changing a track in a program	29
Tuning stations automatically	19	Clearing a track in a program	29
Tuning stations manually	19	Clearing a whole program	29
Storing preset stations	20	Playing CDs over (repeat play)	30
Tuning preset stations	20	Repeating a single CD	30
Scrolling through preset stations	21	Repeating all loaded CDs	30
Using the CD player	22	Repeating programmed tracks	30
The front panel controls and display	22	To stop repeat play	30
		Playing tracks in random order (random play)	31
		To select another track during random play	31
		To cancel random play	31
		Using a timer to play CDs	31

Using the cassette deck	32
The front panel controls and display	32
Before using the cassette deck	34
Preventing accidental recording on pre-recorded tape	34
If there is slack in the tape	34
Storing cassettes	34
Special tapes	34
Listening to tapes	35
Playing tapes	35
Fast-winding tapes	35
Recording tapes	36
Setting the recording level	36
Recording a tape	37
Copying (dubbing) a tape	37
Maintaining the cassette deck	38
Cleaning the heads	38
Demagnetizing the heads	38
Troubleshooting guide	39
Receiver	39
CD player	40
Cassette deck	40
Specifications	42
Receiver (KR-796)	42
CD player (DP-R896)	42
Cassette deck (KX-W595)	42
Speakers (JL-886 main, CRS-123 center, CRS-123 surround and SW-30 subwoofer)	43

Welcome

Now that you've set up your SPECTRUM system, the real fun begins! Operating your system is easy, if you follow the step-by-step instructions in this manual. Spend a little time with the manual before you jump in, so you become familiar with the many capabilities of your system. You'll find a handy table of contents to guide you to the information you need. Then put up your feet, sit back and enjoy the fabulous sound of your SPECTRUM system!

Using the controls

Front panel controls

SPEAKER

TONE CONTROL
knobs

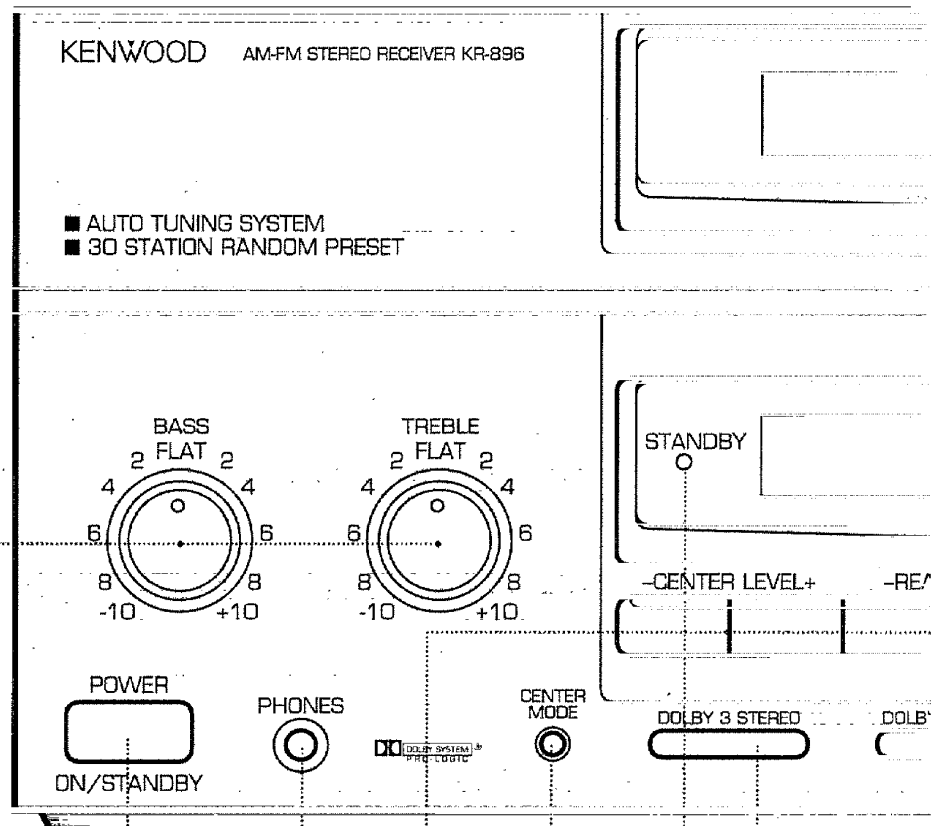

POWER button

HEADPHONES
jack

CENTER MODE
button

STANDBY
indicator

CENTER LEVEL buttons
REAR LEVEL buttons
DELAY TIME buttons

DOLBY 3 STEREO
button

indicator

REMOTE SENSOR

PRESET CALL button

BAND SELECTOR button

MEMORY button

AUTO/MANUAL button

TUNING buttons

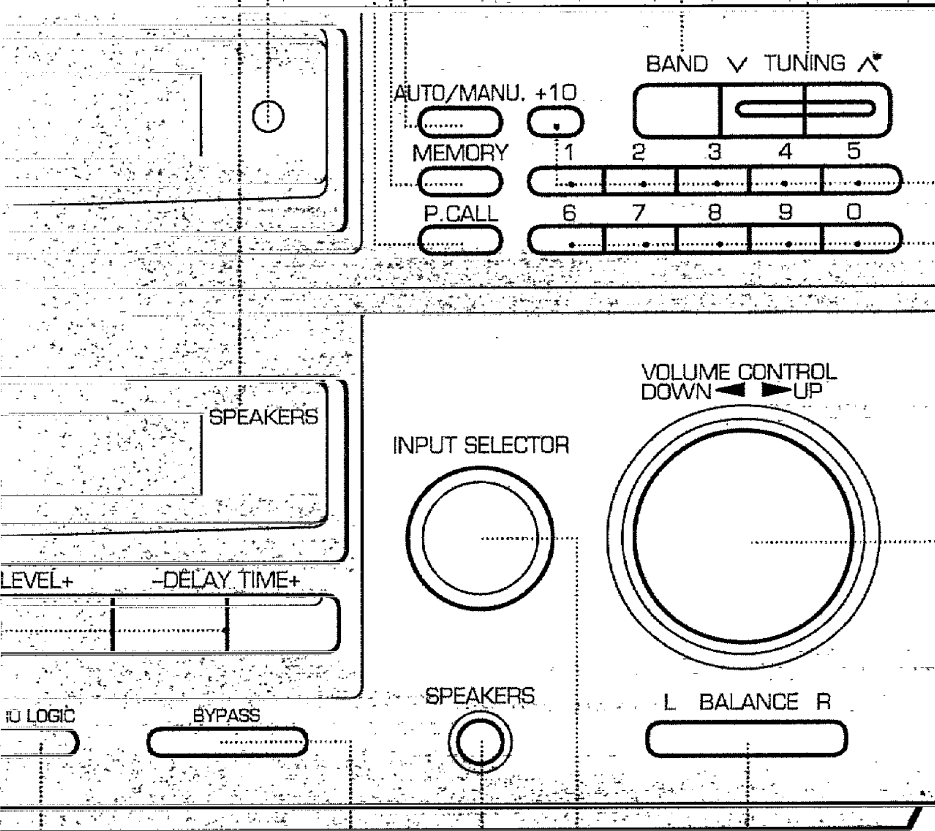

NUMBER buttons

VOLUME CONTROL knob

DOLBY PRO LOGIC button

BYPASS button

SPEAKERS button

BALANCE CONTROL button

INPUT SELECTOR knob

Reading the display

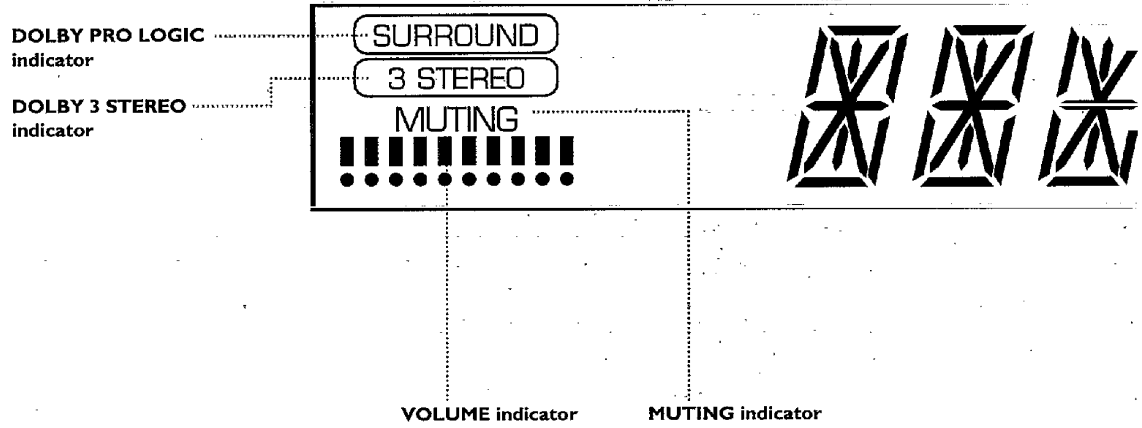
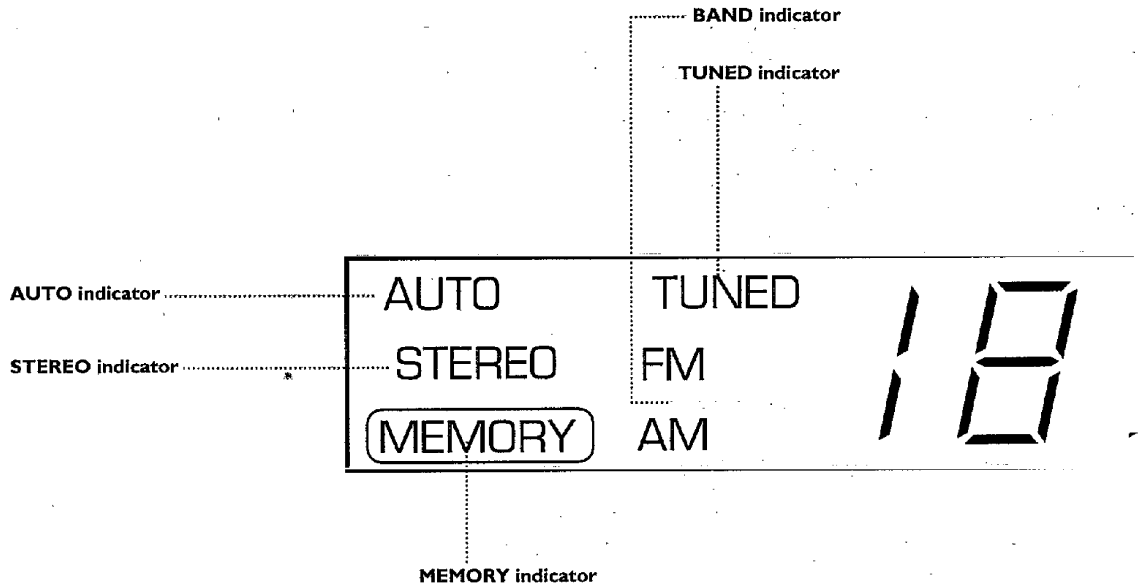

FREQUENCY indicator

CHANNEL indicator

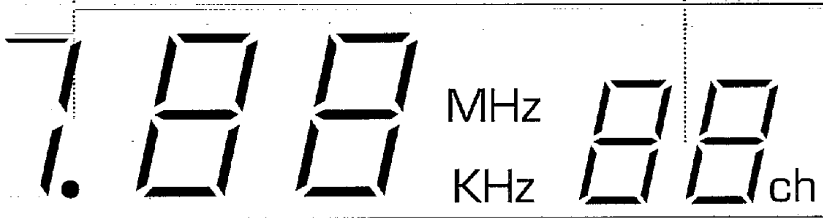

UPPER (tuner)

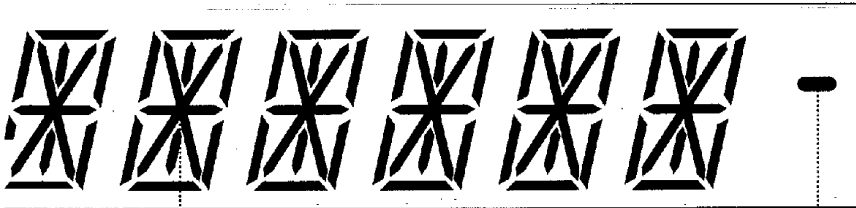

LOWER (amplifier)

INFORMATION display
INPUT SELECTOR indicator
L/R BALANCE indicator

SPEAKERS indicator

The remote

You can use your SPECTRUM system remote for many functions.

A few tips

- Depending on temperature, humidity, and other environmental conditions, the operating range of your remote is approximately 30' and up to 30° on either side of the receiver's remote light sensor.
- When the operating distance of your remote begins to get shorter, replace both alkaline batteries with new ones.

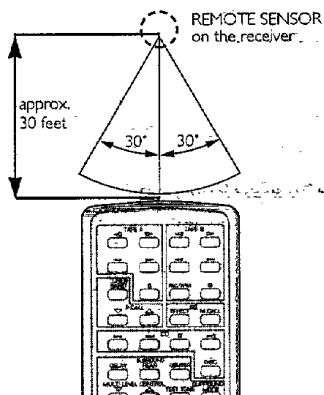

- When you press 2 buttons one after the other, press each button securely for more than 1 second each.
- The remote may malfunction if direct sunlight or high-frequency fluorescent light enters the light sensor. In this case, either move the audio system, or remove the light source.

Important:

The batteries that came with this system are test batteries and may not last as long as alkaline batteries.

TUNER buttons

- **TUNER BAND:** Press to switch between FM and AM
- **P. CALL:** Press to scroll through preset stations

CD PLAYER buttons

- Press ► to play disc, press again to pause disc
- Press ■ to stop disc
- Press ►► to skip to the next track
- Press ◀◀ to skip to the previous track
- Press DISC to change to next disc

INPUT SELECTOR button

Press to scroll through input choices

POWER button

Press to turn the system ON or OFF

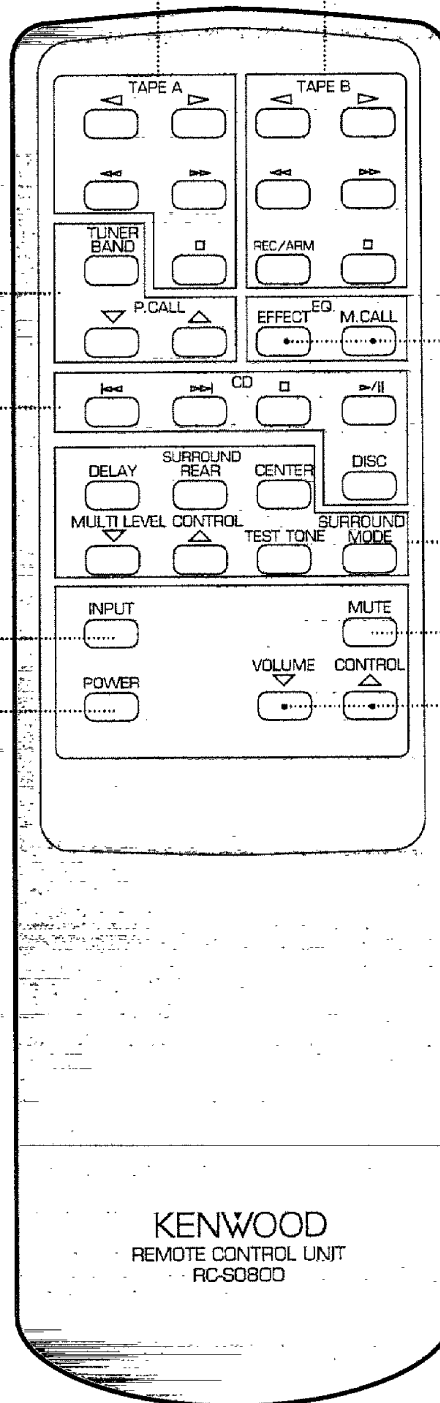

CASSETTE DECK

buttons

Note: These buttons only work with a Kenwood cassette deck with system control connections (not included with this system)

- Press ◀ or ▶ to play or reverse tape
- Press ◀◀ or ▶▶ to fast-forward or rewind tape
- Press ■ to stop tape
- Press REC/ARM to put the player into RECORD/PAUSE mode

EQUALIZER buttons

For use with an optional equalizer

- Press EFFECT to activate and deactivate EQ circuits
- Press M. CALL to activate EQ curves stored in memory

SURROUND SOUND

buttons

- MODE: Press to cycle through Dolby Pro Logic, Dolby 3 Stereo and Bypass
- TEST TONE: Press to turn the test noise ON and OFF
- CENTER: Press to adjust the center speaker level
- REAR: Press to adjust the rear speaker levels
- DELAY: Press to adjust the delay time
- MULTI-LEVEL CONTROL: Press to make center, rear and delay adjustments

MUTE button

Press to MUTE the sound, press again to turn ON sound

VOLUME buttons

Press ▲ or ▼ to increase or decrease volume

Loading and replacing the batteries

If the receiver doesn't respond when you press a button on the remote, you need new batteries. We recommend replacing both batteries at the same time for longer battery life.

1 Remove the cover by pressing down on the ridged area and sliding it off in the direction of the arrow.

2 Insert 2 AA-size alkaline batteries (be sure to pay attention to the (+) and (-) signs when you're inserting the batteries).

3 Close the cover:

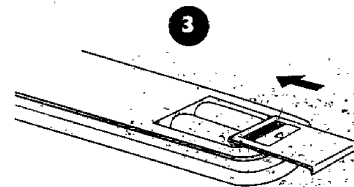
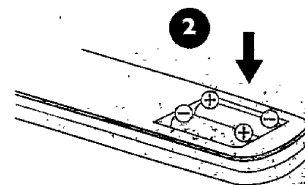
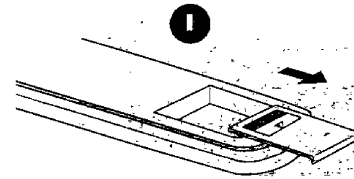

The basic audio functions

Selecting the input source

You can play audio from as many as 5 different sources, including:

- TUNER
- CD
- PHONO
- TAPE
- VIDEO

Selecting from the front panel

Rotate the INPUT SELECTOR knob until you see the input source you want on the display.

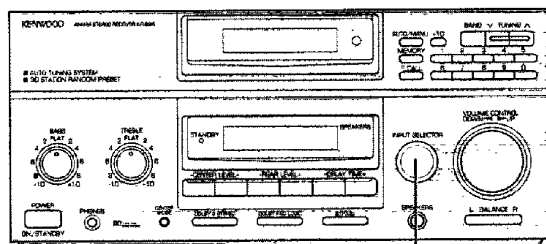

Selecting from the remote

Press the INPUT button until you see the input source you want on the display.

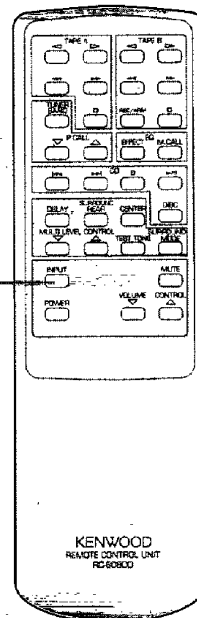

Adjusting the volume

You can increase or decrease the volume level in 1 decibel (dB) increments. The display shows the decibel level change.

Adjusting from the front panel

Turn the VOLUME knob clockwise to increase the volume. Turn the knob counter-clockwise to decrease it.

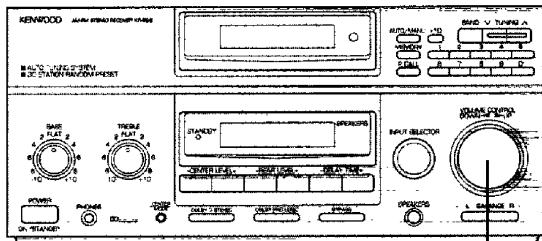

Adjusting from the remote

Press the VOLUME buttons to increase or decrease the volume level.

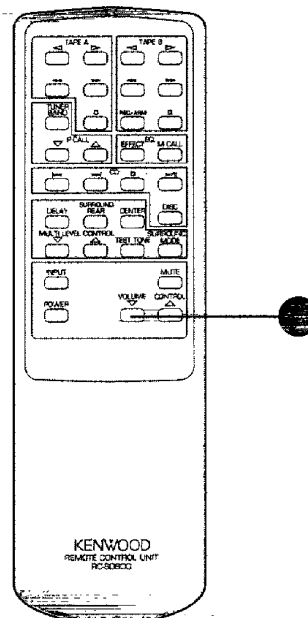

Activating the speakers

You can turn the speakers ON or OFF (for example, to use headphones) with the SPEAKERS button.

- 1 Press the SPEAKERS button (while they are off) to turn the speakers ON.
- 2 Press the SPEAKERS button again to turn the speakers OFF.

The SPEAKERS light on the display turns ON when the speakers are ON, and it goes OFF when the speakers are OFF.

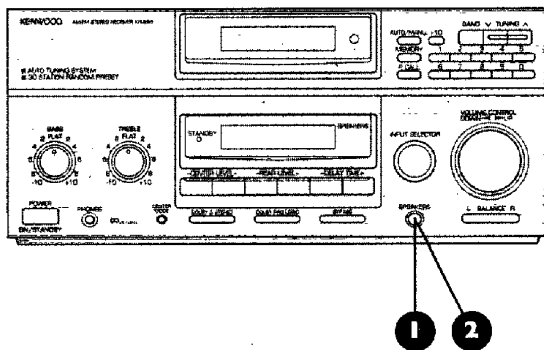

Adjusting the speaker balance

You can adjust the balance of the volume between the left and right speakers.

- 1 Press the L BALANCE button to decrease the right speaker volume and maintain the left.
- 2 Press the R BALANCE button to decrease the left speaker volume and maintain the right.

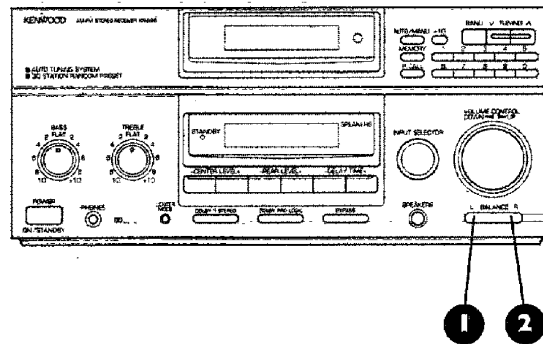

While you're adjusting the balance, the display shows the relative volume between the left and right speakers.

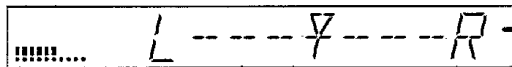

Using headphones

You can use headphones to listen to music in private.

- 1 Turn the speakers OFF.
- 2 Insert the headphone plug into the HEADPHONE jack, and then put them on.

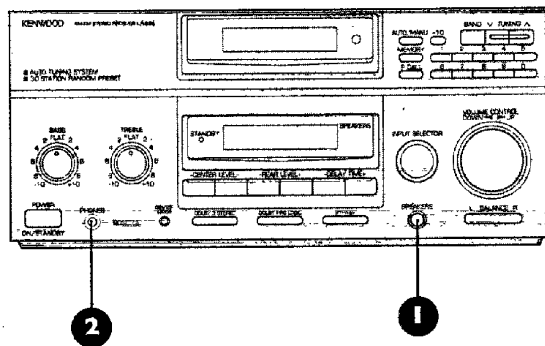

Important

There are a few things to keep in mind when using headphones:

- Turn the volume down before switching the speakers back on.
- You can use your headphones with the speakers on but be careful. The volume delivered through the headphones is usually lower than that delivered through speakers. When you turn the volume up for the headphones, be careful not to turn it up so loud you damage your speakers.

About the audio modes

Using one of the system's audio modes, you'll get optimum sound from your system, whether you're playing music or watching a movie.

Dolby Pro Logic

Use it for movies, music videos, stereo TV broadcasts, and audio CDs recorded in Dolby Surround, and some older films with the Dolby Stereo logo. Dolby Pro Logic is designed to recreate the surround sound from films, music videos, and stereo TV broadcasts encoded in Dolby Surround. It'll bring out the full effect of Dolby Surround-encoded audio CDs and even do a great job with standard CDs.

Dolby 3 Stereo

Use it for movies, music videos, stereo TV broadcasts, and audio CDs recorded in Dolby Surround, and some older films with the Dolby Stereo logo. Dolby 3 Stereo takes Dolby Surround-encoded movies and decodes the sound for a system without surround speakers.

Bypass

Use it for audio CDs not recorded in Dolby Surround, and tapes, records, and TV broadcasts not encoded in Dolby Surround. Bypass mode uses the left and right front speakers for standard music play. It's called 'bypass' because it bypasses the surround processing.

Selecting an audio mode

Selecting from the front panel

Select the appropriate button for DOLBY PRO LOGIC, DOLBY 3 STEREO, or BYPASS.

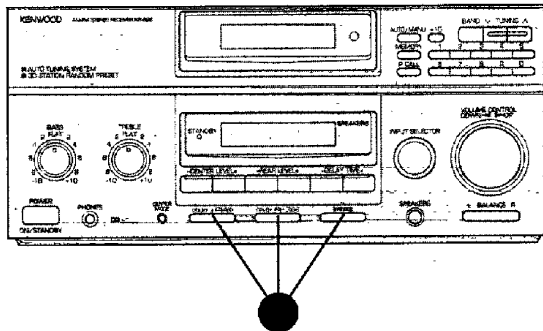

Selecting from the remote

Press the SURROUND MODE button to scroll through DOLBY PRO LOGIC, DOLBY 3 STEREO, and BYPASS.

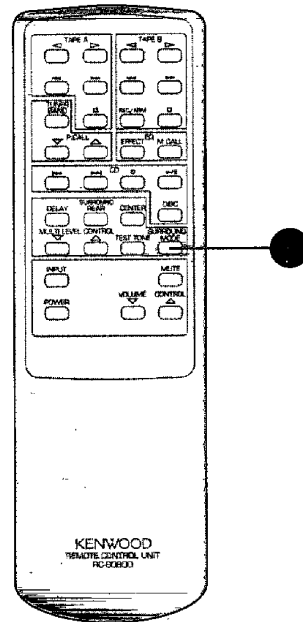

Using the tuner

Tuning stations automatically

You can automatically find the strongest radio station signals.

- 1 Select the TUNER input.
- 2 Press the BAND button to select FM or AM.
- 3 Press the AUTO/MANU button to select AUTO. The AUTO indicator light turns ON.
- 4 On the TUNING buttons, press ▲ to move up the broadcast band, or ▼ to move down the broadcast band.

The tuner stops automatically when it finds a strong station, and the TUNED light turns ON. If the station is broadcasting in stereo, the STEREO light turns ON.

- 5 Press ▲ or ▼ again to find the next strong signal.

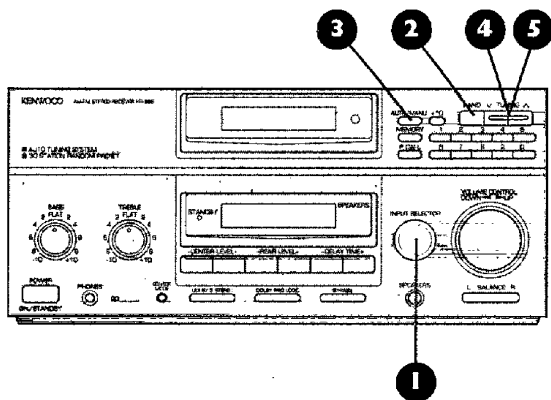

Tuning stations manually

You can search for radio stations in small steps up and down the broadcast band to tune in a weak station that automatic tuning might miss.

- 1 Select the TUNER input.
- 2 Press the BAND button to select FM or AM.
- 3 Press the AUTO/MANU button to select MANUAL. The AUTO indicator light turns OFF.
- 4 On the TUNING buttons, press ▲ to move up the broadcast band, or ▼ to move down the broadcast band to the station you want.

The frequency changes by 0.1 MHz (FM) or 10 kHz (AM) each time you press the button, or it continually changes if you hold the button down.

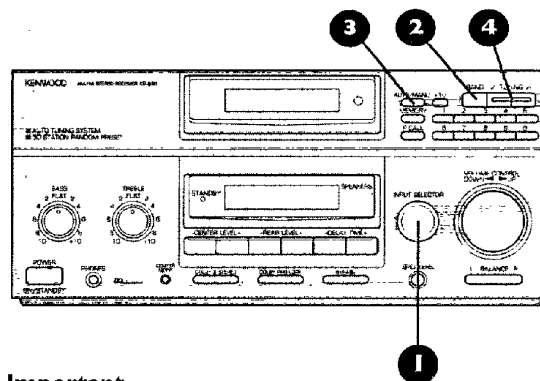

Important

During manual tuning, the tuner receives stations only in mono.

- To receive a tuned station in stereo, press the AUTO/MANU button so the AUTO light turns ON. If the station is broadcast in stereo, you receive it in stereo.
- You may receive weaker stations with more background noise in stereo than in mono. To decrease the noise, press the AUTO/MANU button so the AUTO light goes OFF.

Storing preset stations

You can store up to 30 of your favorite radio stations in memory.

- 1 Tune in the station you want to preset.
- 2 Press the MEMORY button. The MEMORY light turns ON.
- 3 Within 5 seconds, enter the preset number using the number buttons. For example, to select preset #15, press the +10 button, then 5. To select preset #20, press the +10 button, the +10 button again, then 0.

If you've already assigned a station to a preset number, assigning a new station erases the old one.

- 4 To preset additional stations, repeat these steps.

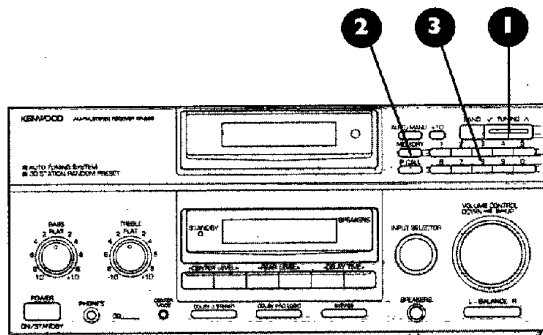

Tuning preset stations

You can quickly tune to any preset station.

- 1 Select the tuner input.
- 2 Press the number buttons assigned to the station.

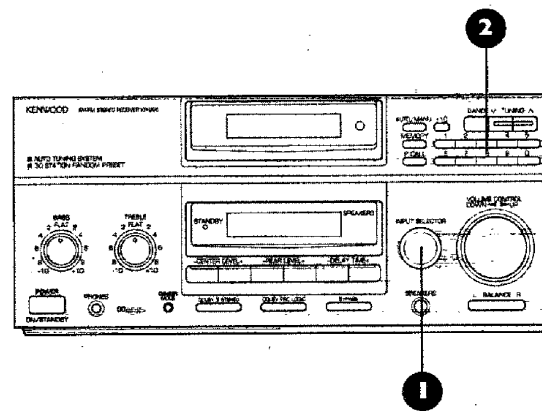

Using the CD player

The front panel controls and display

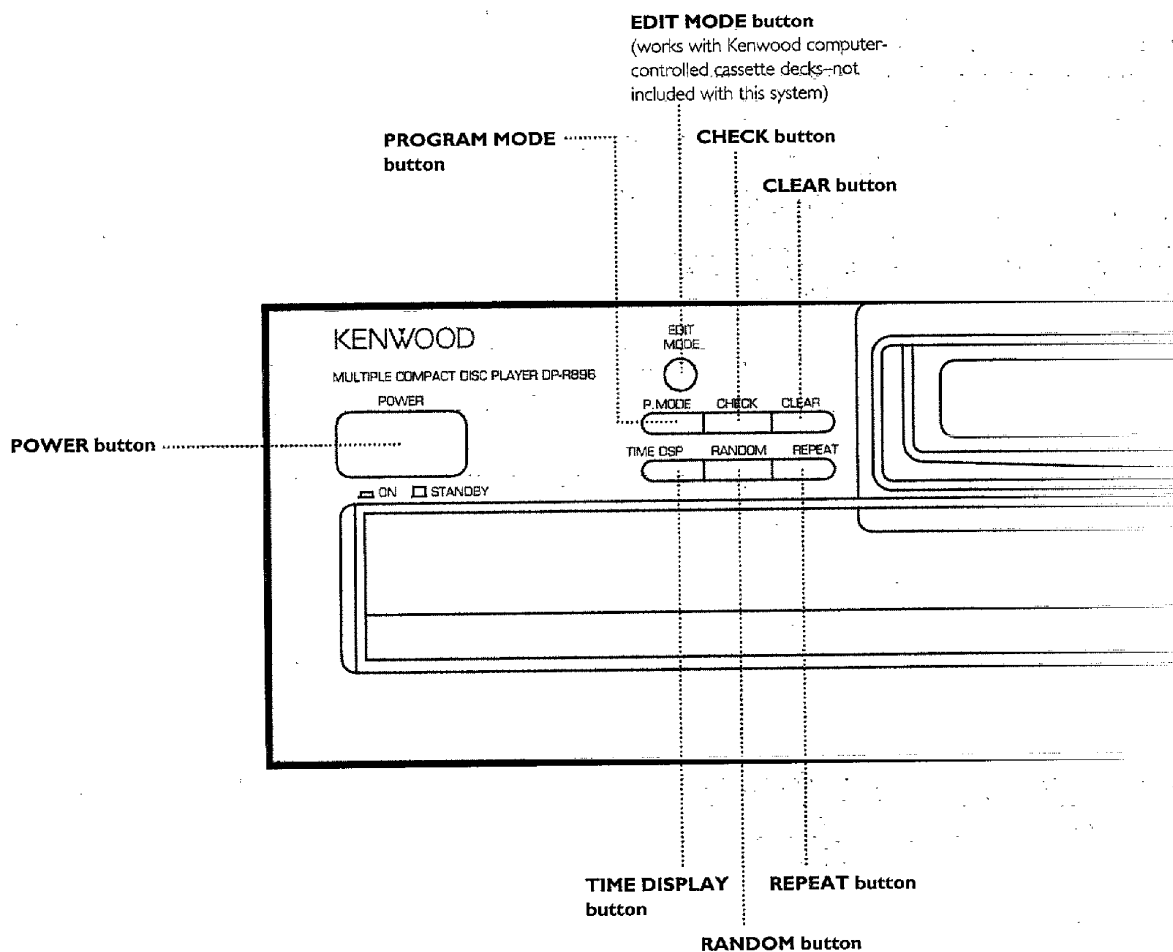

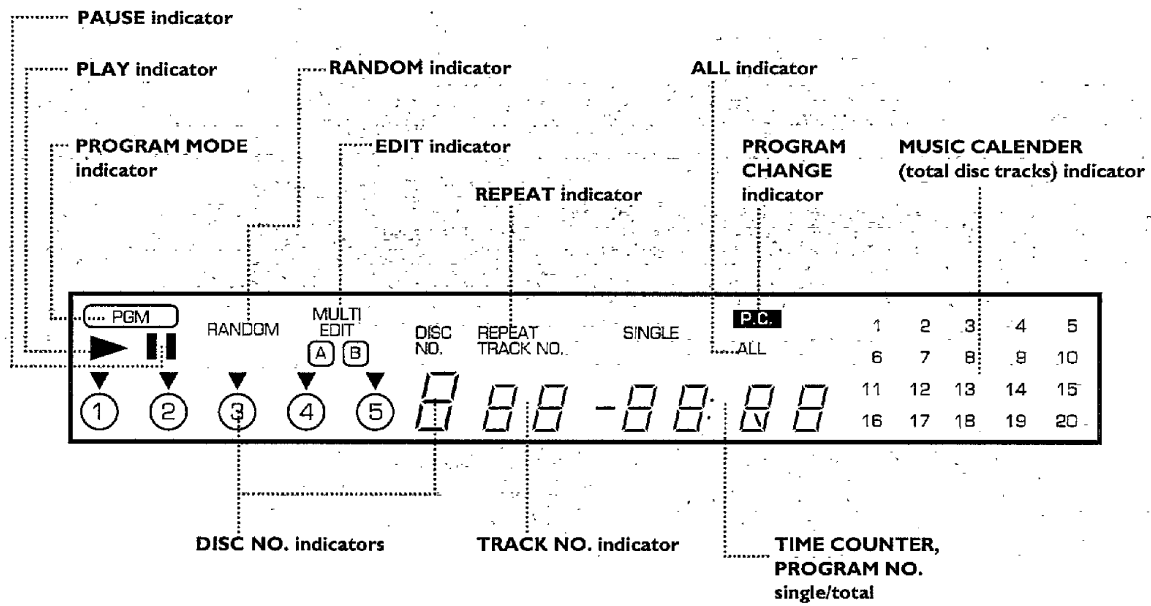

DISC SELECTOR buttons (1-5)
 DISC SKIP button

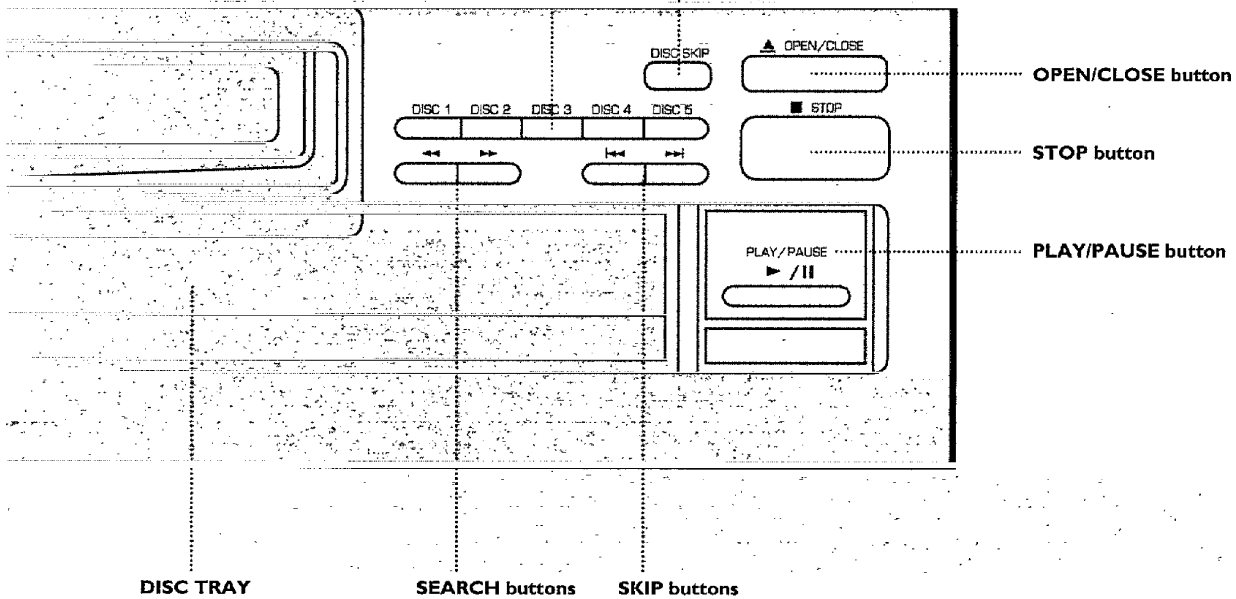

Before using the CD player

Please read the following instructions carefully to help prevent damage to your CD player and your CDs.

Compatible CDs

Your CD player plays standard 5" CDs and 3" CD singles and the audio portion of CDV discs and CD-G (CD plus graphics) discs.

Handling CDs

Hold a CD by its edges and center hole. Don't touch the playing surface or attach labels or tape to either side of the CD.

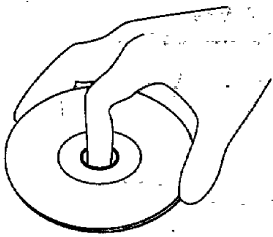

Cleaning CDs

To clean fingerprints or other dirt from a CD, gently wipe it with a soft cotton cloth moving in straight lines outward from the center.

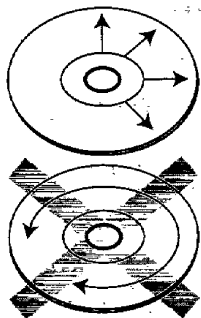

Storing CDs

To protect your CDs, store them in their cases. Don't leave them in the player for a long time.

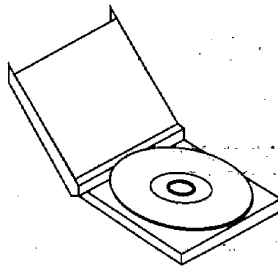

Damaged CDs

To avoid possible damage to your player, don't attempt to play cracked or warped CDs.

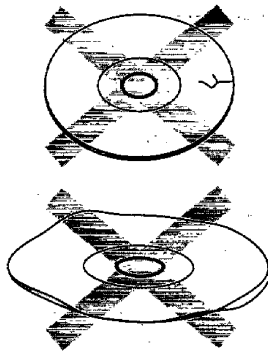

Condensation

Condensation of water vapor on the pickup lens may prevent proper operation of your CD player. To eliminate the condensation, leave the player ON for several hours. Condensation may occur when:

- You bring the player from a cool or cold place to a warm or humid place.

- You operate a heater in the vicinity of the player.
- There's a big difference between the player's internal temperature and the temperature of the room the player is in.

Before you transport your CD player

- 1 Turn the player's power ON. Don't load any CDs.
- 2 Wait until 5 seconds after NO DISC appears on the display.
- 3 Turn the player's power OFF.

Displaying CD time information

You can view time information for the CD you're playing.

Press the TIME DISP. button to cycle between:

TRACK TIME: Elapsed and remaining time of the current track.

TOTAL TIME: Elapsed and remaining time of the CD.

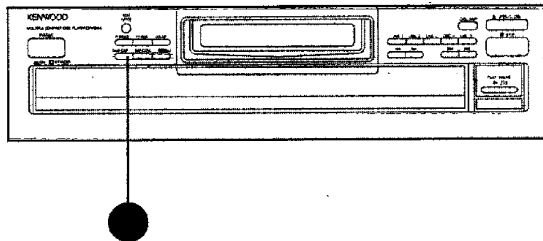

Loading CDs

- 1 Press the OPEN/CLOSE button to open the tray.
- 2 Place a CD in one of the tray's circular wells. While the tray is open, you can insert a CD in each of the 2 exposed wells.

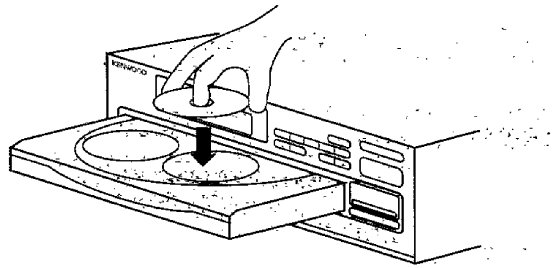

- 3 To insert more CDs, press the DISC SKIP button to rotate the tray. Insert a CD when the tray stops rotating.
- 4 When you're done, press the OPEN/CLOSE button to close the tray.

Changing CDs

During play

- 1 Press the OPEN/CLOSE button to open the tray.
- 2 Change CDs in the exposed wells. If you want to put a CD in an unexposed well, press the DISC SKIP button to rotate the tray. You can't change the CD currently playing.

When the player is stopped

- 1 Press the OPEN/CLOSE button to open the tray.
- 2 Change CDs in the exposed wells. If necessary, press the DISC SKIP button to rotate the tray.

Playing CDs

From the beginning

Playing from the front panel

- 1 Load one or more CDs.
- 2 Select the CD using the DISC SELECTOR buttons. An indicator ▼ appears on the display over the number of the selected CD. The selected CD automatically begins playing.

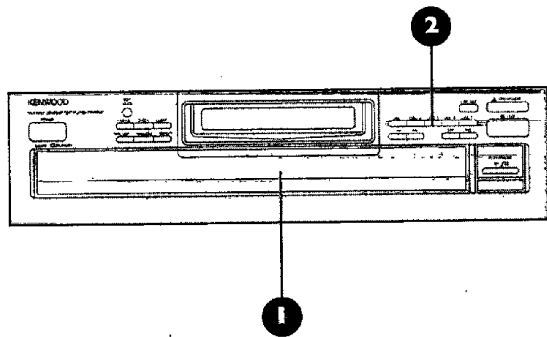

Whether you use the front panel or remote:

- If you don't select a CD when you've inserted more than 1 CD, the CDs play in order, starting with the CD in the lowest-numbered CD well.
- If you don't select a CD and you press the PLAY/PAUSE button, play begins with the CD number currently indicated on the display.

Playing from the remote

- 1 Load one or more CDs.
- 2 Press the DISC button until the indicator ▼ appears on the player's display over the number of the selected CD. The selected CD automatically begins playing.

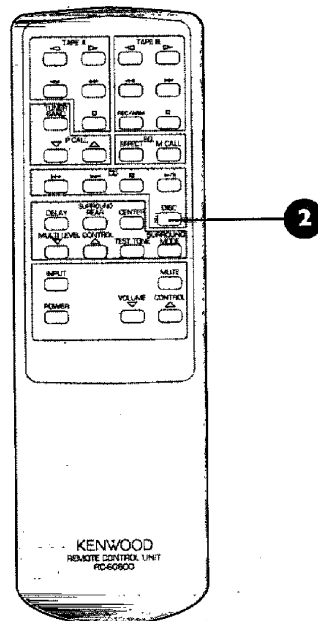

From a specific track

Playing from the front panel

- 1 Make sure that the PGM (Program Mode) light is OFF. If the PGM light is ON, press the P.MODE button.
- 2 Select the CD using the DISC SELECTOR buttons.
- 3 Select the track using the I◀◀ and ▶▶I buttons. Play begins from the selected track and continues.

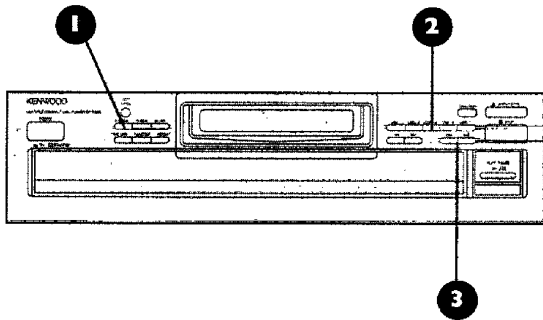

Playing from the remote

- 1 Make sure that the PGM light is OFF. If the PGM light is ON, press the P.MODE button.
- 2 Select the CD using the DISC button.
- 3 Select the track using the I◀◀ and ▶▶I buttons. Play begins from the selected track and continues.

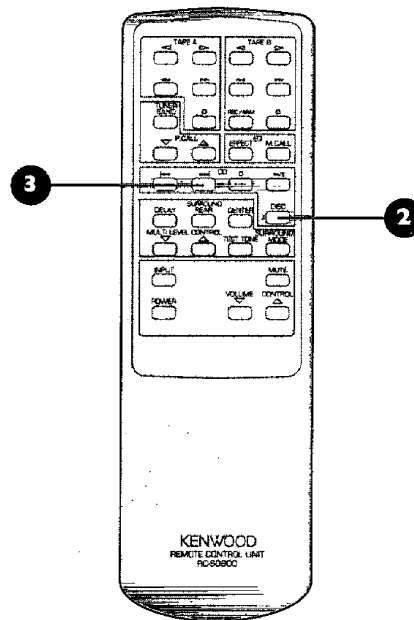

Playing a combination of tracks

You can program up to 32 tracks from any combination of CDs to play in any order.

A few hints:

- The player automatically adds a space of about 4 seconds between tracks in the PGM mode. This makes it easy to record tapes that are compatible with the track-finding function of Kenwood cassette decks. However, the PGM mode also inserts a 4-second space between 2 continuous, consecutive tracks programmed into memory, such as those on classical and live recordings.
- If you select the wrong track, press the CLEAR button, and select the correct track.
- When selecting tracks using the number buttons on the remote, you don't have to press the P.MODE button after each selection.
- Once you've programmed 32 tracks, the display indicates FULL, and you can't program any more tracks.
- If you press **⏮** or **⏭** buttons during Programmed play, the player skips the current track either forward or backward.

Programming tracks

- 1 Press the STOP button.
- 2 Press the P.MODE button. The PGM light turns ON.
- 3 Select a CD.
- 4 Select a track.
- 5 Press the P.MODE button. The PLAY light flashes, and the display shows the selected CD and track and indicates P—01.
- 6 Repeat steps 3 through 5 above to program each track.
- 7 Press the PLAY button to play.

You can program all the tracks on a CD (in order) by pressing the P.MODE button without selecting any track numbers. The CD takes up only 1 program memory slot, regardless of how many tracks are on it.

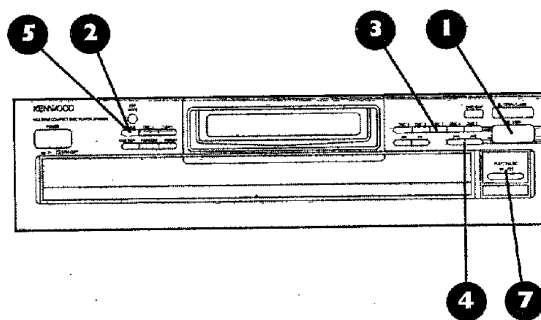

To check a program

Press the CHECK button. Each time you press the button, you see the CD and track numbers in the order you programmed them on the display.

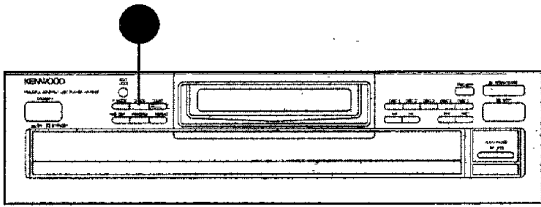

To resume normal play

Press the P.MODE button. After the current track is done, the tracks continue to play in the order on the CD.

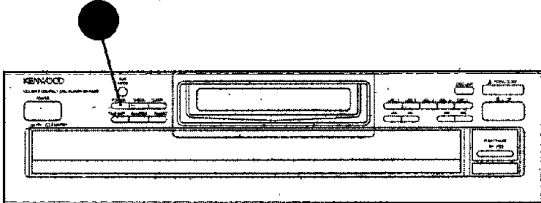

To stop play

Press the STOP button.

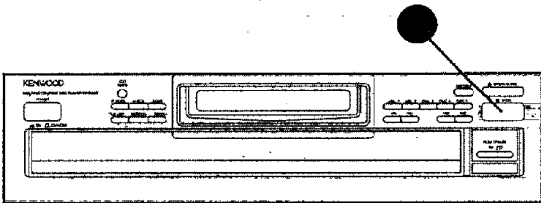

Adding a track to a program

You can add another track to the end of a program after the program has started playing.

- 1 Press the STOP button.
- 2 Select the CD and track to add.
- 3 Press the P.MODE button.

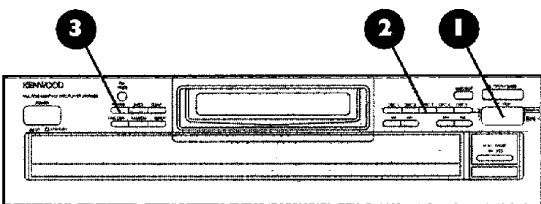

Changing a track in a program

You can change a track in a program after the program has started playing.

- 1 Press the STOP button.
- 2 Press the CHECK button until you see the P.# you want on the display. The P.C. light turns ON.
- 3 Select the new CD and track.
- 4 Press the P.MODE button.

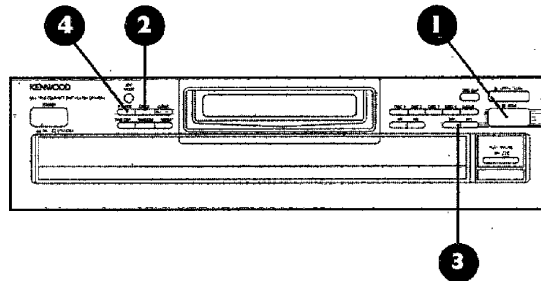

Clearing a track in a program

You can clear upcoming tracks in a program while it's playing.

Press the CLEAR button. Each time you press the button, you clear the tracks in order from the last track. You can't clear the track currently playing.

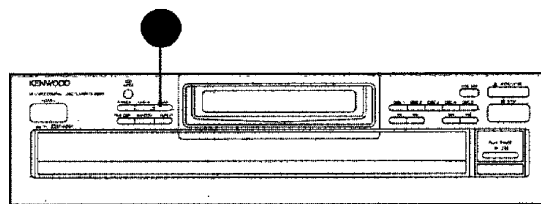

Clearing a whole program

Press either the P.MODE button or the OPEN/CLOSE button.

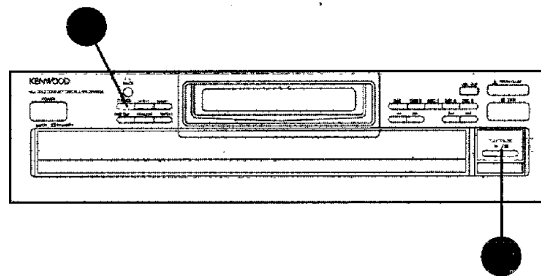

Playing CDs over (repeat play)

You can repeat a single CD, all loaded CDs, or the contents of a program.

Repeating a single CD

- 1 Press the STOP button.
- 2 Press the P.MODE button. The PGM light turns ON.
- 3 Select a CD.
- 4 Press the P. MODE button. The ALL indicator light turns ON.
- 5 Press the REPEAT button. The REPEAT light turns ON.
- 6 Press the PLAY button.

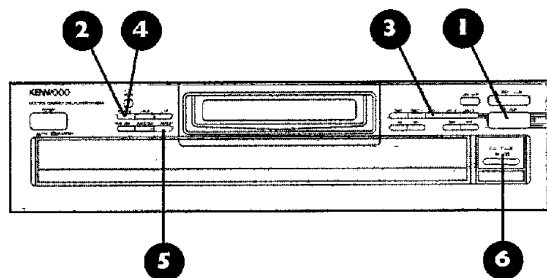

Repeating all loaded CDs

- 1 Make sure that the PGM light is OFF. If the PGM light is ON, press the P.MODE button.
- 2 Press the REPEAT button. The REPEAT light turns ON.
- 3 If you weren't already playing CDs, press the PLAY button.

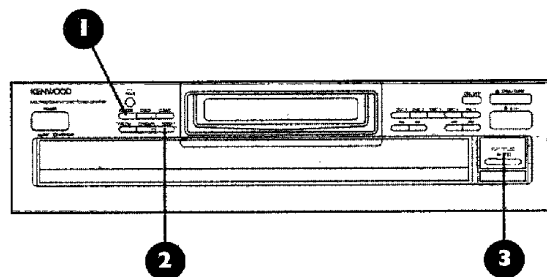

Repeating programmed tracks

You can repeat a programmed combination of tracks (see page 28, 'Programming Tracks'). If you only programmed 1 track, it plays over and over again.

- 1 Make sure that the program is playing (and the PGM light is ON).
- 2 Press the REPEAT button. The REPEAT light turns ON.

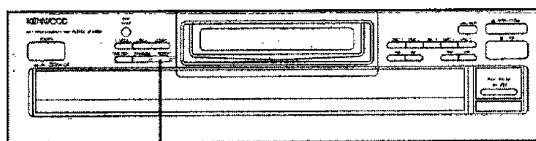

To stop repeat play

Press the REPEAT button while repeat play is ON. The REPEAT light goes OFF.

Playing tracks in random order (random play)

You can randomly play all the tracks from the CDs in the tray without repeating any tracks.

- 1 Make sure the PGM light is OFF. If the PGM light is ON, press the P.MODE button.
- 2 Press the RANDOM button. The RANDOM light turns ON, and the MUSIC CALENDAR flashes.

Random play continues until all tracks have been played.

You can continuously repeat random play by pressing the REPEAT button during random play.

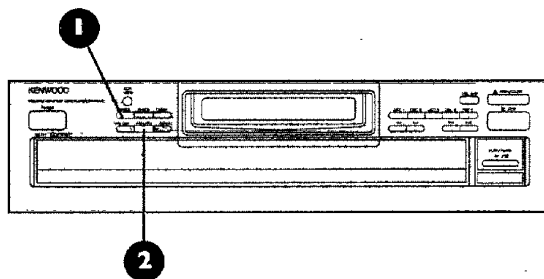

To select another track during random play

Press the Forward TRACK SKIP button.

To cancel random play

Press either the STOP, OPEN/CLOSE, or RANDOM buttons. If you press RANDOM, normal play starts from the track you're currently playing.

Using a timer to play CDs

You can use your CD player with an audio timer (you'll have to buy it on your own) to play CDs at a time you choose.

- 1 Connect the power cords of the SPECTRUM system to the audio timer so that the timer turns the system on. Be sure to follow the instructions included with the timer.
- 2 Turn the system ON.
- 3 Insert 1 or more CDs. If you insert more than 1 CD, play begins with the CD in the lowest-numbered CD well.
- 4 Set the volume.
- 5 Set the timer. At the set time, the system will turn on, and the CD player will begin playing.

Using the cassette deck

The front panel controls and display

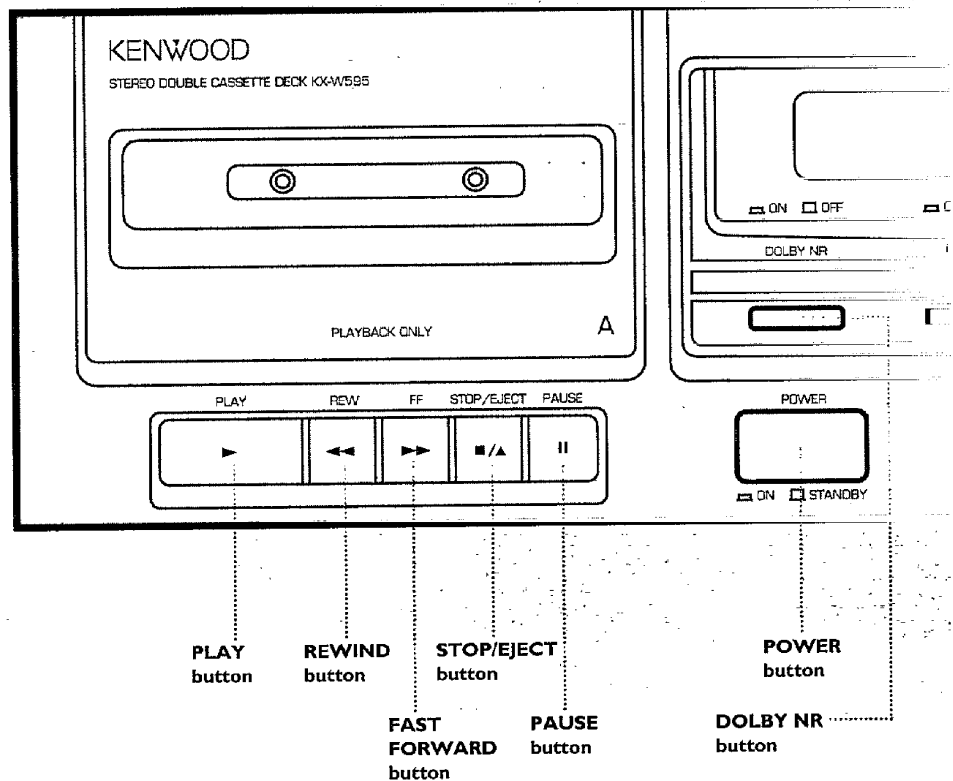

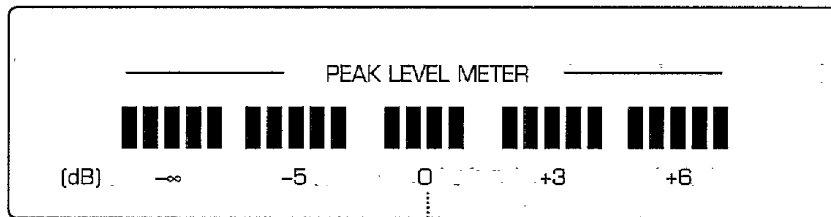

RECORDING indicator

DUBBING indicator

DOLBY NR
reference level

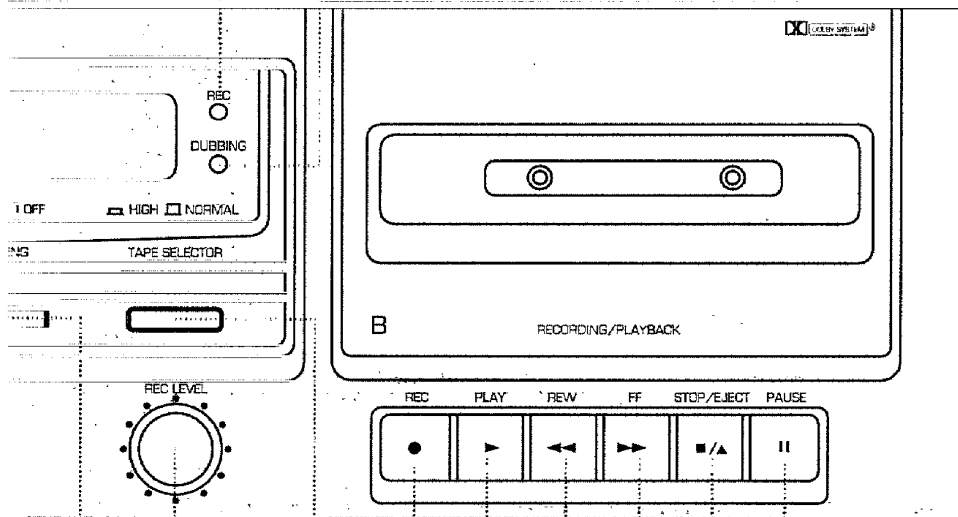

RECORDING LEVEL
knob

DUBBING button

TAPE SELECTOR
button

RECORDING
button

PLAY
button

REWIND
button

FAST
FORWARD
button

STOP/EJECT
button

PAUSE
button

Before using the cassette deck

Please read the following instructions carefully to help prevent damage to your cassette tapes.

Preventing accidental recording on pre-recorded tape

To prevent the accidental recording of a tape, use a small screwdriver or other tool to remove the recording-activation tabs on the top edge of the cassette case.

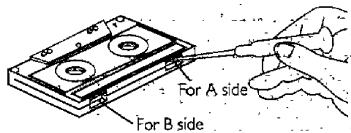

To record on the tape after you've removed the tabs, use cellophane tape to cover the portion of the hole previously covered by the tabs. Covering the entire hole may interfere with the operation of the cassette deck's automatic tape-type sensing mechanism.

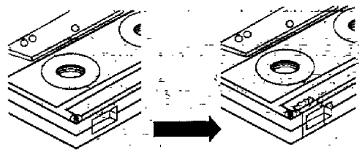

If there is slack in the tape

Insert a pencil into the tape reel hole, and wind the excess tape into the cassette case.

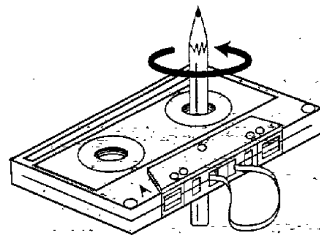

Storing cassettes

Store tapes away from direct sunlight, magnetic fields (including those produced by speakers and television sets), and heaters.

Special tapes

Using 120-minute tapes and/or endless tapes could damage the tape mechanisms. We don't recommend them.

Listening to tapes

Playing tapes

- 1 Insert a tape into a tape well. On tape A, the tape type (Normal or Chrome) is automatically selected. On tape B, press the TAPE SELECTOR button to select the proper tape type.

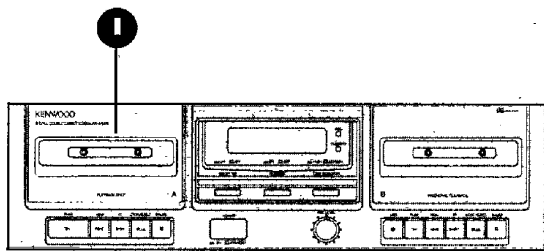

- 2 Select Dolby Noise Reduction for the tape you're playing. For example, if you're playing a tape recorded using Dolby, select ON.
- 3 Press the ► button to begin play.
- 4 Press the ■ button to stop play.

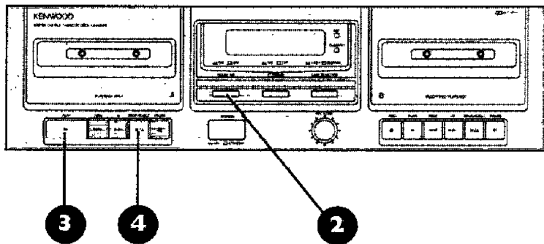

Fast-winding tapes

- 1 Press the ■ button to stop play.
- 2 Press the ►► button to fast-forward through the tape, or press the ◀◀ button to rewind through the tape.
- 3 Press the ■ button to stop fast-winding.

Recording tapes

You can record tapes from any source connected to your system: CDs, other tapes, records (if you've connected a record player), the radio, and even the audio portion of videotapes or laser discs (if you have these components connected).

A few tips:

- To record tapes, use tape-well B.
- You can't make recordings on metal tapes.
- Dolby Noise Reduction reduces tape hiss produced during the record/play process. Dolby B is the most widely used noise reduction system on pre-recorded tapes. Be sure you mark the tapes you record either Dolby B or not so you can play them back properly.

Setting the recording level

Setting the proper recording level is an important part of making good tapes. If the recording level is too low, tape hiss may mask the music's softer parts. If the recording level is too high, the music may sound distorted. These instructions help you set the optimum recording level.

- 1 Put a blank tape in tape-well B.
- 2 Press the PAUSE button, and then press the REC and PLAY buttons simultaneously.
- 3 Set the input of the receiver to the source you want to record. You can't select TAPE.
- 4 Find a loud section from the source you want to record, and play it.
- 5 Using the REC LEVEL knob, adjust the recording level so that the level indicators flash at 0 dB on the music's loudest passages. Turn the knob clockwise to increase the recording level or counter-clockwise to reduce it.

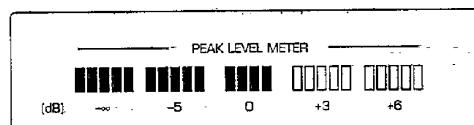
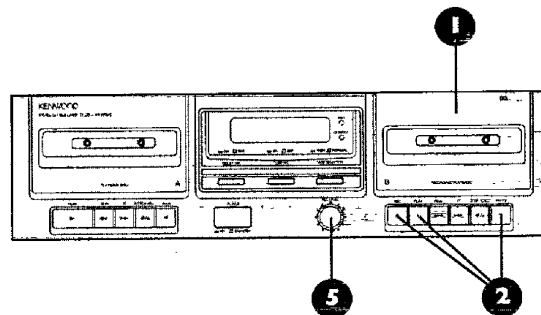

Recording a tape

- 1 Put a blank tape in tape-well B.
- 2 Press the PAUSE button, and then press the REC and PLAY buttons simultaneously.
- 3 Set the input of the receiver to the source you want to record. You can't select TAPE.
- 4 Set the record level (see above).
- 5 Set the source at the beginning.
- 6 Press the PAUSE button to release the cassette from pause.
- 7 Play the music source.

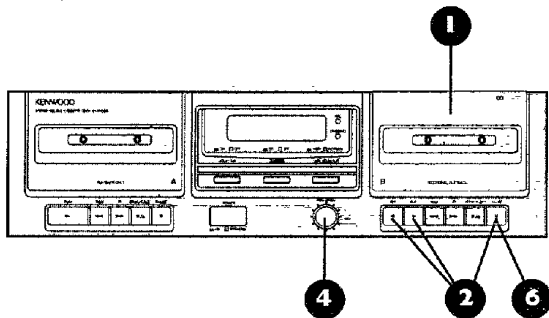

To pause the recording

Press the PAUSE button.

To resume recording

Press the PAUSE button again.

To stop recording

Press the STOP button.

Copying (dubbing) a tape

You can automatically copy a tape in tape-well A onto a tape in tape-well B.

A few tips about recording tape-to-tape:

- You can't adjust recording level during copying. It is set automatically.
- The new recording in tape-well B will automatically have the same noise reduction as the original recording in tape-well A. This means you can't add Dolby Noise Reduction during dubbing.

- 1 Insert the tape to copy into tape-well A, and a blank tape into tape-well B.
- 2 Select the tape type for tape-well B.
- 3 Press the DUBBING button.

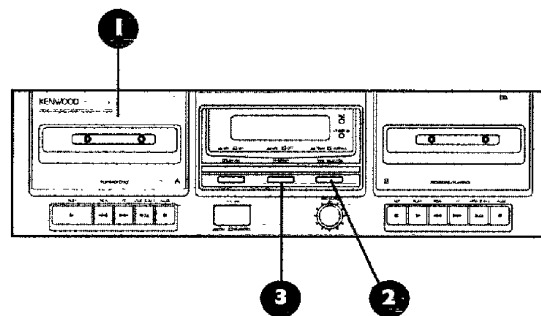

- 4 Press the REC and PLAY buttons for tape-well B simultaneously.

- 5 Press the PLAY button for tape-well A. Dubbing starts automatically.

- Dubbing stops automatically when the side has been recorded.
- Remember to turn the DUBBING switch OFF after you've finished dubbing the tape.

To pause dubbing

Press the PAUSE button for tape-well B.

To resume dubbing

Press the PAUSE button for tape-well B again.

To stop dubbing

Press the STOP/EJECT buttons for both tape-wells.

Maintaining the cassette deck

Performing routine maintenance helps keep your cassette deck operating at peak performance.

Cleaning the heads

We recommend that you clean the head assemblies, tape guides, capstans, and pinch rollers of both cassette wells after every 10 hours of use. For best results, use tape head cleaning fluid and long-handled cotton swabs. (Using alcohol to clean the pinch rollers may cause them to dry out over a long period of time.) Be careful not to press too hard during cleaning, because the parts are precisely aligned.

- 1 Open the cassette well doors.
- 2 Dip a swab into the cleaning fluid, and clean the surface of the heads.

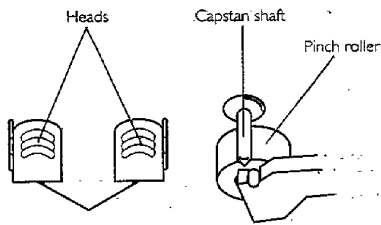

- 3 Using a clean swab, clean the capstan shafts, making sure to clean all the way around them.
- 4 Using a clean swab, clean the pinch rollers, making sure to clean all the way around them. Use a clean swab to keep them from turning.

Demagnetizing the heads

Since tape is magnetic, when the tape heads and capstan shaft contact the tapes, they become magnetized over time, increasing distortion. Playing tapes on a deck with magnetized heads and capstans can also deteriorate the recordings on the tapes. For best performance, use a head demagnetizer to demagnetize the heads and capstans of both cassette wells.

Troubleshooting guide

Sometimes things just don't seem to be working right.

When this happens:

- First, look back over this manual to find the instructions for what you're trying to do. You may find the solution to your problem right there.
- If that doesn't work, look for the problem in this Troubleshooter's guide.
- If you have a problem with another component, check the manual for that unit.
- If you still can't solve the problem, call the store where you purchased your system, or call a Kenwood Authorized Service Center.

To find a Kenwood Authorized Service Center

- Call 1-800-536-9663, in the continental US, 24 hours a day, 7 days a week.

Receiver

Remote doesn't operate

- Check the batteries, and replace them if needed.
- Check that the remote is close enough to the system; that the controlling angle is small enough; that there's no obstacle in between.
- Check that you've placed your CD, videotape, laser disc, or other source in the proper player.
- Check to make sure that the audio cables and system control cables are connected properly.

No sound from the system

- Check that the volume is set at a proper level.
- Check that the mute is OFF.

- Check that the speakers are turned ON. If the speakers are ON, the speaker indicator is ON.
- Check that all your power cords are connected properly.
- Check that the speaker cables are connected properly.
- Check that the input cable from the source component is connected properly.
- Check that the shorting plugs have not been removed from the ADAPTER loop jacks.

No sound from one of the speakers

- Check that the balance between the left and right speakers isn't set too far to one side.
- Check that the audio and speaker cables are connected properly.

No sound from the subwoofer

- Check that the subwoofer's power chord is properly plugged into a wall outlet, and that its power switch is ON. If the switch is ON, the power indicator is ON.
- Check that the audio cable is connected properly.
- Check that the subwoofer volume control is not turned all the way down.

No sound from the surround speaker(s) and/or center speaker, or the sound is abnormally low

- Check that one of the surround modes is ON.
- Check that the center channel isn't set to PHANTOM.
- Check that the speaker cables are connected properly.
- Check that the CENTER and SURROUND channels are calibrated properly.

The STANDBY light blinks, but there is no sound

- Check that the speaker cables aren't short-circuited—that is, the (+) and (-) wires aren't touching each other. If they are, separate the wires.

A hum when you select the PHONO input

- Check that the audio cables are plugged securely into the PHONO jacks.
- Check that the turntable is grounded on the rear panel. The ground wire should be connected to the screw labeled GND.

None of the functions operate, or the display shows wrong information

- Reset the unit's microcomputer by unplugging the power cord from the AC outlet and plugging it back in while holding down the POWER button.

You can't receive radio stations

- Check that the station is tuned in properly.
- Check that the TUNER input is selected.
- Check that the antenna is connected properly.

You can't receive a preset station by pressing the corresponding number buttons

- Check that the TUNER input is selected.
- Check that the preset station is a receivable frequency.
- Check that the preset memory hasn't been cleared because the power cord was unplugged a long time. If so, preset the station again.

Interference with reception

- Check for interference from electrical appliances. If so, turn them OFF.
- Check for interference from the TV set. If so, turn it OFF, or move the antenna away from the TV.
- Check for interference from automobiles. If so, install the outdoor antenna away from roads.

CD player

Power light doesn't come on

- Check that the power cord is properly plugged into the AC outlet on the back of the receiver.

Player doesn't play a loaded CD

- Check that the CD is loaded right-side up.
- Check that the CD isn't cracked or dirty.
- There may be condensation on the lens. Leave the player on for at least 1 hour before using it.

No sound

- Check that the CD is loaded properly.
- Check that the CD isn't cracked or dirty.
- Check that the PLAY mode is active (the PLAY indicator light should be ON).
- Check that the audio cables are connected properly.

Skipping (mis-tracking)

- Check that the CD isn't cracked or dirty.
- Make sure that the player isn't subjected to strong vibrations.

CD automatically plays when power is turned on

- Remove all CDs before turning the unit OFF. The player is designed to automatically begin playing when the power is turned ON.

Cassette deck

No sound when the PLAY button is pressed

- Check that the tape isn't blank.
- Check that the tape is wound properly in the cassette shell. If not, replace the tape.
- Check that the audio cables are connected properly.
- Check that the tape heads are clean.

None of the operation buttons work

- Make sure that a tape has been inserted into the well.
- Make sure the cassette well door is completely closed.
- Make sure that the tape isn't fully wound to the end. If it is, reinsert the tape facing the other direction.
- Check that the tape is wound properly in the cassette shell. If not, replace the tape.

Recordings sound dull

- Check that the tape heads are clean.
- The recording level may be too high. Set the recording level according to the section 'Setting the recording level' on page 36.
- Make sure that Dolby Noise Reduction isn't activated when playing tapes recorded with no Dolby Noise Reduction.

Recordings are distorted

- The recording level may be too high. Set the recording level according to the section 'Setting the recording level' on page 36.

Pressing the REC and PLAY buttons simultaneously doesn't start recording

- Make sure that the recording-activation tabs have not been removed from the tape.
- Make sure that the cassette well door is completely closed.
- Check that the recording level isn't set to minimum.
- Check that the tape isn't fully wound to the end.

Tape noise (hiss) level is high

- Make sure that the proper Dolby Noise Reduction is selected for play.
- Make sure that the head is demagnetized properly.
- The tape may have been recorded at too low a recording level. If so, record it again at a higher level.

Sound is 'sour', with unstable pitch

- Make sure that the capstans and pinch rollers are clean.

- Make sure that the tape is wound properly in the cassette shell.

None of the functions operate, or the display shows wrong information

- Reset the unit's microcomputer by unplugging the power cord from the AC outlet and plugging it back in while holding down the STOP button.

Specifications

Receiver (KR-796)

Power amp section

Power output in stereo operation: 100 watts per channel minimum RMS, both channels driven at 8 ohms, from 40 Hz to 20 kHz, with no more than 0.09% total harmonic distortion (FTC)

Power output in surround operation: Left and Right channels: 70 watts per channel, 1 kHz, 0.9% THD, 8 ohms, Center channel: 30 watts, 1 kHz, 0.9% THD, 8 ohms, Surround channel: 15 watts + 15 watts, 1 kHz, 0.9% THD, 8 ohms

Pre amp section

Signal-to-noise ratio (IHF-A):
Phono: 70 dB
CD, Tape, Video: 95 dB

Input sensitivity/impedance:
Phono: 3.5 mV/47 k-ohms
CD, Tape, Video: 200 mV/47 k-ohms

Tone controls:
Bass: ± 10 dB at 100 Hz
Treble: ± 10 dB at 10 kHz

FM tuner section

Tuning frequency range:
87.5 MHz ~ 108 MHz

Useable sensitivity (IHF):
13.2 dBf (1.2 mV at 75 ohms)

50 dB quieting sensitivity (stereo):
41.2 dBf (3.2 mV at 75 ohms)

Total harmonic distortion (1 kHz)
Stereo: 0.7%

Mono: 0.6%

Signal-to-noise ratio at 65 dBf (IHF)
Stereo: 68 dB
Mono: 75 dB

Selectivity (IHF +400 kHz): 50 dB

Stereo separation at 1 kHz (IHF):
40 dB

Frequency response:
30 Hz ~ 15 kHz, +0.5 dB, -3.0 dB

AM tuner section

Tuning frequency range:
530 ~ 1700 kHz

Usable sensitivity:
12 mV/(500 mV/m)

Total harmonic distortion: 0.7%

Signal-to-noise ratio: 48 dB

Selectivity: 30 dB

General

Power consumption: 2.5 A

AC outlet (2 switched): 200 W
1.6 A max. total

Dimensions
Width: 17-5/16"
Height: 7-9/16"
Depth: 11-13/16"
Weight (net): 23.1 lb

CD player (DP-R896)

Format

Laser: Semiconductor laser

Channel format: 2 channel

Disc rotation speed: 200 ~ 500 rpm
(CLV)

D/A converters: Dual 1 Bit

Oversampling digital filter:
8 fs (352.8 kHz)

Performance

Frequency response: 4 Hz ~ 20 kHz,
+1.0 dB

Signal-to-noise ratio: >96 dB

Dynamic range: >94 dB

Total harmonic distortion + noise:
<0.007% (1 kHz)

Channel separation: >90dB (1kHz)

Wow and flutter: Unmeasurable

Output level/impedance:
2.0 V/3.3 k-ohms

General

Power consumption: 10W

Dimensions
Width: 17-5/16"
Height: 5-1/16"
Depth: 15-7/16"
Weight (net): 11 lb

Cassette deck (KX-W595)

Format

Track system: 4 track, 2 channel

Recording system: AC bias
(105kHz)

Heads

Well-A: Playback head x 1

Well-B: Record/playback head x 1,

Erase head x 1

Performance

Wow and flutter: 0.3% (WRMS)

Fast-wind time: Approx 110
seconds (C-60 tape)

Frequency response:

Normal tape: 30 Hz ~ 13k Hz, +3 dB

High-bias tape: 30 Hz ~ 13 kHz, +3 dB

Signal-to-noise ratio: (3% 3rd
harmonic distortion, high bias tape):

Dolby NR OFF: >57 dB

Dolby B NR ON: >66 dB

Harmonic distortion (315 Hz,
250 nWb/m, high bias tape): <1%

Input sensitivity/impedance:
122.8 mV/47 k-ohms

Output level/impedance:
775 mV/3.3 k-ohms

General

Power consumption: 12 W

Dimensions:

Width: 17-5/16"

Height: 5-1/16"

Depth: 9-13/16"

Weight (net): 8.8 lb

Speakers

Main speakers (JL-886)

Drivers:

Woofer: 8" cone-type

Tweeter: 3" cone-type

Power handling: 140 watts

General

Dimensions:

Width: 11-3/16"

Height: 37-13/32"

Depth: 9-7/16"

Weight (net): 25 lbs

Center speaker

(CRS-123 Center)

Drivers: 1 x 4" full-range cone-type

Power handling: 40 watts

General

Dimensions:

Width: 17-5/16"

Height: 5-1/2"

Depth: 6-1/8"

Weight (net): 5.5 lbs

Surround speakers

(CRS-123 Surround)

Drivers: 1 x 4" full range cone-type

Power handling: 40 watts

General

Dimensions:

Width: 7-1/2"

Height: 5-1/2"

Depth: 6-1/8"

Weight (net): 3.1 lbs

Subwoofer (SW-30)

Driver: 1 x 8" cone-type

Amplifier power output:

30 watts minimum RMS at 4 ohms,
from 20 Hz to 200 Hz, with no
more than 0.04% total harmonic
distortion (FTC)

General

Dimensions:

Width: 13"

Height: 13"

Depth: 12-5/8"

Weight (net): 23 lbs

Because Kenwood follows a policy
of continuous product improve-
ment, these specifications may be
changed without notice.

KENWOOD USA CORPORATION
PO Box 22745
Long Beach, California 90801-5745

